

Part number

CAP 10 CS2



Brief description:

surface mounting housings with 4 pegs, size "57.27", metal cover, Pg21 x 2, metal version, IP65

Product description

Version	metal version
Series	Surface housings, with 4 pegs
Product type	with 4 pegs and gasket
Variant	metal cover
Style	high construction
Family	CLASS enclosures
Size	size "57.27"

Technical data

Operating temperature range (min, max)	-40°C ... +125°C
Material	metal
IP degree of protection	IP65
Cable entry	Pg21 x 2

Further technical details

Weight	335,00 g
--------	----------

Approvals / Standards

Quality mark	 (type:4/4X/12),  , EAC
Conformity	CQC, CE

General ordering information

EAN13 code	8015747007580
Tariff number	85369095

Packaging Information

Packaging length	475,00 mm
Packaging height	200,00 mm
Packaging width	150,00 mm
Packaging weight	3,35 kg
Packaging volume	14,25 dm ³
Packaging description	Carton box
Packaging quantity	10 Pcs
Packaging EAN code	8015747236256
Sub-packaging weight	1,68 kg
Sub-packaging description	Plastic packaging
Sub-packaging quantity	5 Pcs
Sub-packaging EAN barcode	8015747236263

Part number

CAP 10 CS2

Catalogue drawings

CHP CAP - MHP MAP

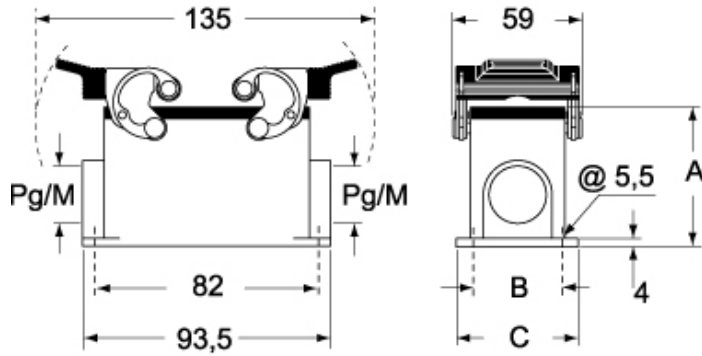

CHP CS/CP CAP CS/CP - MHP CS/CP MAP CS/CP

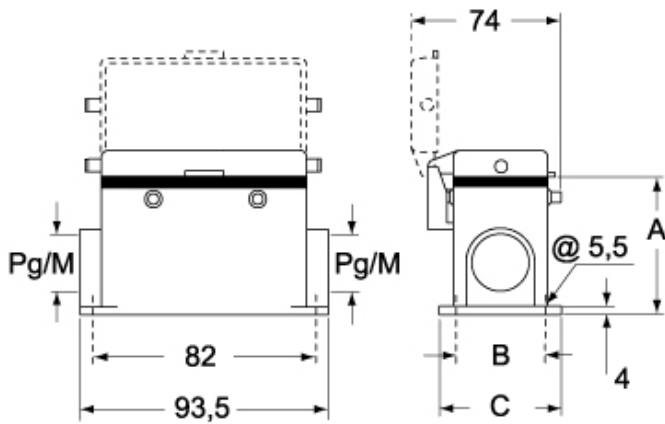

	A	B	C
CHP L / MHP L	57	40	52
CAP L / MAP L	73	45	57
CHP CS / MHP CS	57	40	52
CAP CS / MAP CS	73	45	57
CHP CP / MHP CP	57	40	52
CAP CP / MAP CP	73	45	57